

Part # B26-FUJDX XX+XX

19-0206

PARTS

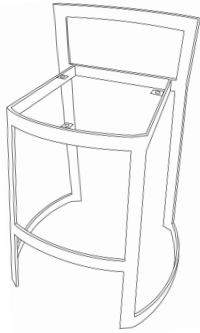

A

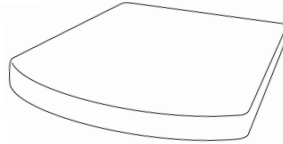

B

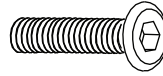

M6 15mm
x3

C

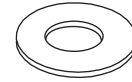

x3

D

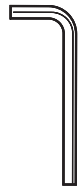

E

1

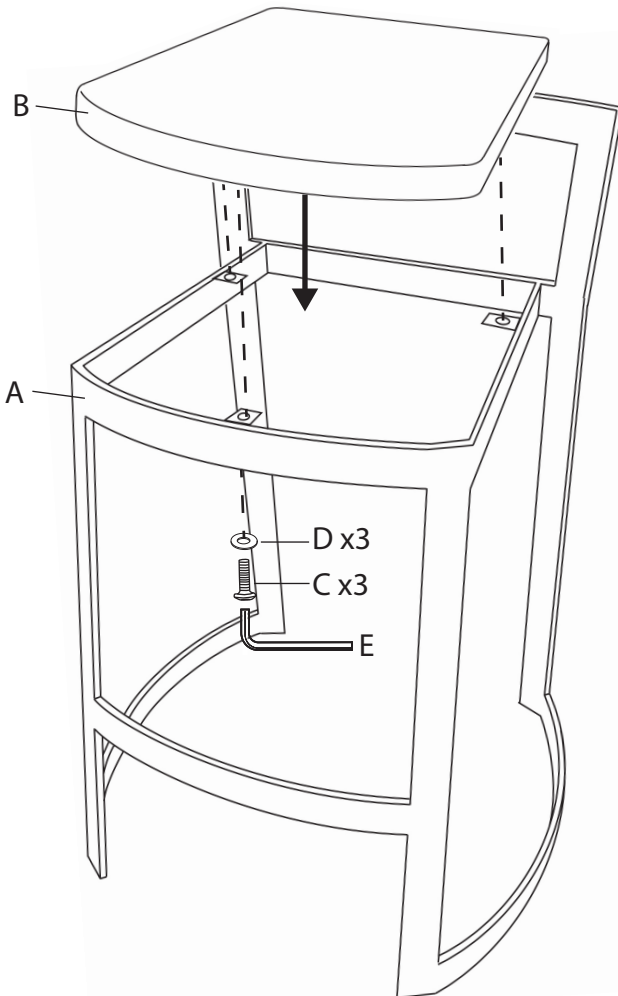

2

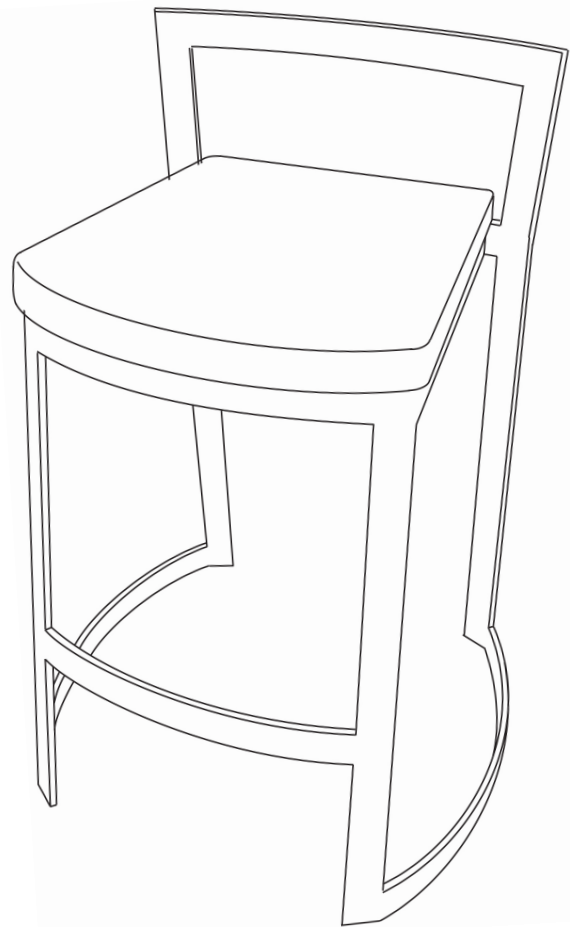

Do not over tighten.
 Do not use power tools to assemble.